

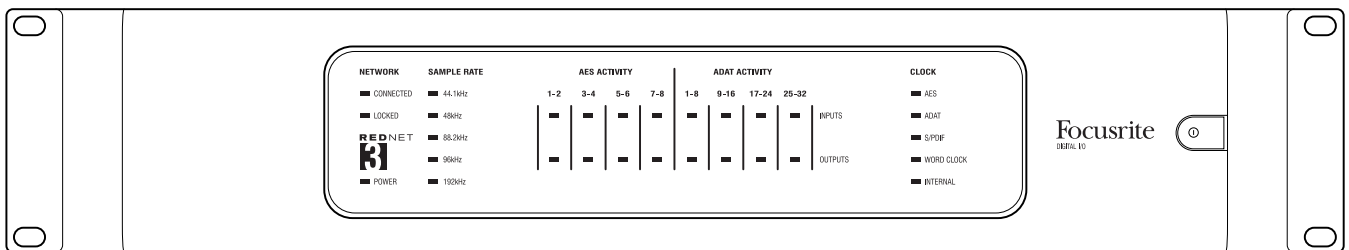

REDNET® 3

User Guide



IMPORTANT SAFETY INSTRUCTIONS

1. Read these instructions.
2. Keep these instructions.
3. Heed all warnings.
4. Follow all instructions.
5. Do not use this apparatus near water.
6. Clean only with dry cloth.
7. Do not block any ventilation openings. Install in accordance with the manufacturer's instructions.
8. Do not install near any heat sources such as radiators, heat registers, stoves, or other apparatus (including amplifiers) that produce heat.
9. Do not defeat the safety purpose of the polarized or grounding-type plug. A polarized plug has two blades with one wider than the other. A grounding type plug has two blades and a third grounding prong. The wide blade or the third prong are provided for your safety. If the provided plug does not fit into your outlet, consult an electrician for replacement of the obsolete outlet.
10. Protect the power cord from being walked on or pinched particularly at plugs, convenience receptacles, and the point where they exit from the apparatus.
11. Only use attachments/accessories specified by the manufacturer.
12.  Use only with the cart, stand, tripod, bracket, or table specified by the manufacturer, or sold with the apparatus. When a cart is used, use caution when moving the cart/apparatus combination to avoid injury from tip-over.
13. Unplug this apparatus during lightning storms or when unused for long periods of time.
14. Refer all servicing to qualified service personnel. Servicing is required when the apparatus has been damaged in any way, such as power-supply cord or plug is damaged, liquid has been spilled or objects have fallen into the apparatus, the apparatus has been exposed to rain or moisture, does not operate normally, or has been dropped.
15. No naked flames, such as lighted candles, should be placed on the apparatus.

The appliance coupler is used as the disconnect device, the disconnect device shall remain readily operable.

Do not use a damaged or frayed power cord.

If the mains plug supplying the apparatus incorporates a fuse then it should only be replaced with a fuse of identical or lower rupture value.

GB The apparatus shall be connected to a mains socket outlet with a protective earthing connection.

FIN Laite on liitettävä suojamaadoituskoskettimilla va rustettuumpistorasiaan

NOR Apparatet må tikoples jordet stikkontakt

SWE Apparaten skall anslutas till jordat uttag



CAUTION
RISK OF ELECTRIC SHOCK
DO NOT OPEN



CAUTION: TO REDUCE THE RISK OF ELECTRIC SHOCK, DO NOT REMOVE COVER (OR BACK). NO USER-SERVICEABLE PARTS INSIDE. REFER SERVICING TO QUALIFIED SERVICE PERSONNEL.



The lightning flash with arrowhead symbol, within equilateral triangle, is intended to alert the user to the presence of uninsulated "dangerous voltage" within the product's enclosure that may be of sufficient magnitude to constitute a risk of electric shock to persons.



The exclamation point within an equilateral triangle is intended to alert the user to the presence of important operating and maintenance (servicing) instructions in the literature accompanying the appliance.

WARNING: TO REDUCE THE RISK OF FIRE OR ELECTRIC SHOCK, DO NOT EXPOSE THIS APPARATUS TO RAIN OR MOISTURE AND OBJECTS FILLED WITH LIQUIDS, SUCH AS VASES, SHOULD NOT BE PLACED ON THIS APPARATUS.

ENVIRONMENTAL DECLARATION

Compliance Information Statement: Declaration of Compliance procedure

Product Identification: Focusrite RedNet
 Responsible party: American Music and Sound
 Address: 4325 Executive Drive
 Suite 300
 Southaven
 MS 38672
 Telephone: 800-431-2609

This device complies with part 15 of the FCC Rules. Operation is subject to the following two conditions: (1) This device may not cause harmful interference, and (2) this device must accept any interference received, including interference that may cause undesired operation.

For USA

To the User:

- 1. Do not modify this unit!** This product, when installed as indicated in the instructions contained in this manual, meets FCC requirements. Modifications not expressly approved by Focusrite may void your authority, granted by the FCC, to use this product.
- 2. Important:** This product satisfies FCC regulations when high quality shielded cables are used to connect with other equipment. Failure to use high quality shielded cables or to follow the installation instructions within this manual may cause magnetic interference with appliances such as radios and televisions and void your FCC authorization to use this product in the USA.
- 3. Note:** This equipment has been tested and found to comply with the limits for a Class A digital device, pursuant to part 15 of the FCC Rules. These limits are designed to provide reasonable protection against harmful interference in a commercial environment. This equipment generates, uses and can radiate radio frequency energy and, if not installed and used in accordance with the instructions, may cause harmful interference to radio communications. Operation of this equipment in a residential area is likely to cause harmful interference in which the user will be required to correct the interference at his own expense

For Canada

To the User:

This Class A digital apparatus complies with Canadian ICES-003.
 Cet appareil numérique de la classe A est conforme à la norme NMB-003 du Canada.

RoHS Notice

Focusrite Audio Engineering Limited has conformed where applicable, to the European Union's Directive 2002/95/EC on Restrictions of Hazardous Substances (RoHS) as well as the following sections of California law which refer to RoHS, namely sections 25214.10, 25214.10.2, and 58012, Health and Safety Code; Section 42475.2, Public Resources Code.

TABLE OF CONTENTS

IMPORTANT SAFETY INSTRUCTIONS	2
INTRODUCTION	5
About this User Guide	6
Box Contents	6
INSTALLATION GUIDE	7
Unit Connections and Features	7
RedNet 3 - Front Panel	7
RedNet 3 - Rear Panel.....	8
Physical Characteristics	10
Power Requirements.....	10
OTHER REDNET SYSTEM COMPONENTS	11
USING REDNET CONTROL	11
APPENDIX	12
Connector Pinouts.....	12
Performance Specifications	14
Focusrite RedNet Warranty and Service	15
Registering Your Product	16
Customer Support and Unit Servicing	16
Troubleshooting	16

INTRODUCTION

Thank you for purchasing this Focusrite RedNet 3.

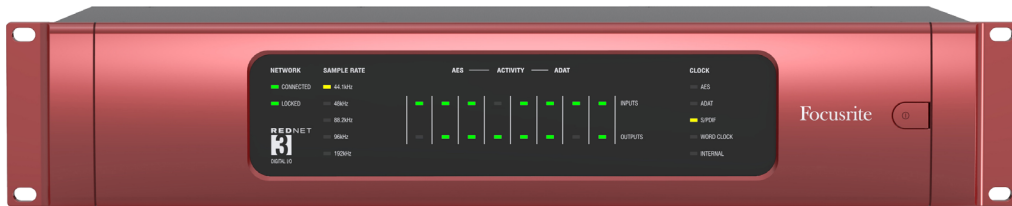

RedNet 3 is a multichannel, bidirectional digital audio interface for use with a RedNet digital audio networking system.

RedNet is a powerful, low latency, digital audio networking system designed specifically for music, recording studio and broadcast applications. It is based on Audinate's Dante™, a well-established audio networking technology known for its extreme robustness. Dante - and the RedNet system - is capable of transporting up to 512 channels of bidirectional audio (at 48 kHz sample rate) over a single Gigabit Ethernet link. The number of channels available in your DAW will depend on the host method being used.

RedNet 3 provides up to 64 channels of digital I/O (32 inputs, 32 outputs), in ADAT format. The ADAT connectivity consists of eight optical inputs and eight optical outputs. ADAT Inputs 1 to 4 and Outputs 1 to 4 can each carry 8 audio channels at 44.1 or 48 kHz. Outputs 5 to 8 duplicate the lower-numbered ports at these sample rates. At higher sample rates, Inputs 5 to 8 and Outputs 5 to 8 are used for the higher-numbered channels, and the per-port channel count is reduced from 8 to 4 (at 96 kHz) or to 2 (at 192 kHz).

The AES/EBU I/O makes Input and Output channels 1 to 8 available on a 25-pin Dsub connector, in addition to the ADAT format at the optical ports. Sample Rate Conversion (SRC) is available on the AES/EBU inputs; this may be selected from RedNet Control. (Note that the AES/EBU digital format encodes audio channels in pairs.) RedNet 3 is also provided with an S/PDIF input and an S/PDIF output; these carry Channels 1 and 2. Sample Rate Converters (SRCs) are fitted to the S/PDIF input. Word Clock Input and Word Clock Output connectors permit RedNet 3 to be either a master or slave to other digital audio devices outside the RedNet network.

The front panel has LEDs confirming the unit's network status, sample rate and sync source, together with data activity for each group of eight digital inputs and outputs.

About this User Guide

This User Guide applies only to the RedNet 3 digital interface. It provides information about installing a RedNet 3 and how to connect it into your studio system. You will also find a copy of the RedNet System User Guide included with the unit. This Guide provides a detailed explanation of the RedNet system concept, to help you achieve a thorough understanding of its capabilities. We recommend that all users, including those already experienced in digital audio networking, take the time to read through the System User Guide so that you are fully aware of all the possibilities that RedNet and its software has to offer.

If either User Guide does not provide the information you need, be sure to consult www.focusrite.com/rednet, which contains a comprehensive collection of common technical support queries.

Box Contents

- RedNet 3 unit
- RedNet 3 User Guide (this manual)
- RedNet System User Guide
- 2 m Cat6 Ethernet cable
- IEC AC mains cable
- Product registration card with Bundle Code. Registration gives access to:
 - RedNet Control
 - RedNet drivers (installed with RedNet Control)
 - Audinate Dante Controller (installed with RedNet Control)
 - Dante Virtual Soundcard token and download instructions
 - RedNet 3 User Guide (this document) – PDF format
 - RedNet System User Guide – PDF format

INSTALLATION GUIDE

Unit connections and features

RedNet 3 - Front Panel

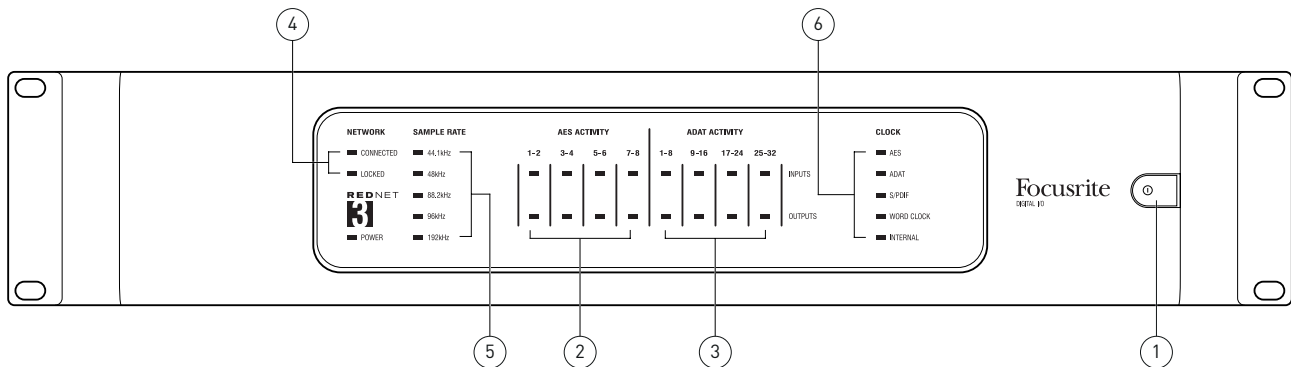

1. AC Power switch
2. **AES ACTIVITY** – four green LEDs which illuminate when a valid AES/EBU digital audio signal is present at the corresponding AES/EBU input. A further set of four indicates the presence of a signal at each of the AES/EBU outputs. Note that the numbering is in pairs, as one AES/EBU signal (input or output) corresponds to two audio channels.
3. **ADAT ACTIVITY** – two sets of four green LEDs which illuminate when a valid digital audio signal in ADAT format is present at the corresponding input or output TOSLINK port. Note that as one port (input or output) can carry 8 channels of audio at a sample rate of 44.1 or 48 kHz, but correspondingly less at higher sample rates, the number of LEDs which will be active is dependent both on the number of ports in use and the sample rate.
4. **NETWORK** status flags – two green LEDs confirming network status:
 - **CONNECTED** – illuminates when the unit is connected to an active Ethernet network
 - **LOCKED** – illuminates when a valid clock sync is received via the network or an external source
5. **SAMPLE RATE** indication – five yellow LEDs; only one of these (**44.1 kHz, 48 kHz, 88.2 kHz, 96 kHz, 192 kHz**) will be lit at a time, to confirm the sample rate that the system is running at.

6. **CLOCK** – One of five yellow LEDs will be illuminated to confirm the currently selected source of clock for the RedNet 3 unit if it is currently selected as Preferred Master in RedNet Control. The clock source is selected in software from RedNet Control, and the options are:
 - **AES** – sync is derived from Channel 1 of the AES/EBU digital audio input.
 - **ADAT** – sync is derived from ADAT input 1.
 - **S/PDIF** – an S/PDIF digital audio signal connected at the rear panel may be used as the sync source.
 - **WORD CLOCK** – a dedicated word clock input is provided on the rear panel to permit RedNet 3 – and the entire RedNet network – to be locked to a studio master word clock source.
 - **INTERNAL** – synchronisation is derived from the RedNet 3’s internal clock. If any of the external sync sources are selected, but no valid signal is available, the unit’s clock source will switch automatically to internal sync. The selected clock (internal or external) is available at a Word Clock Output connector for connection to other digital audio devices outside the RedNet network.

RedNet 3 - Rear Panel

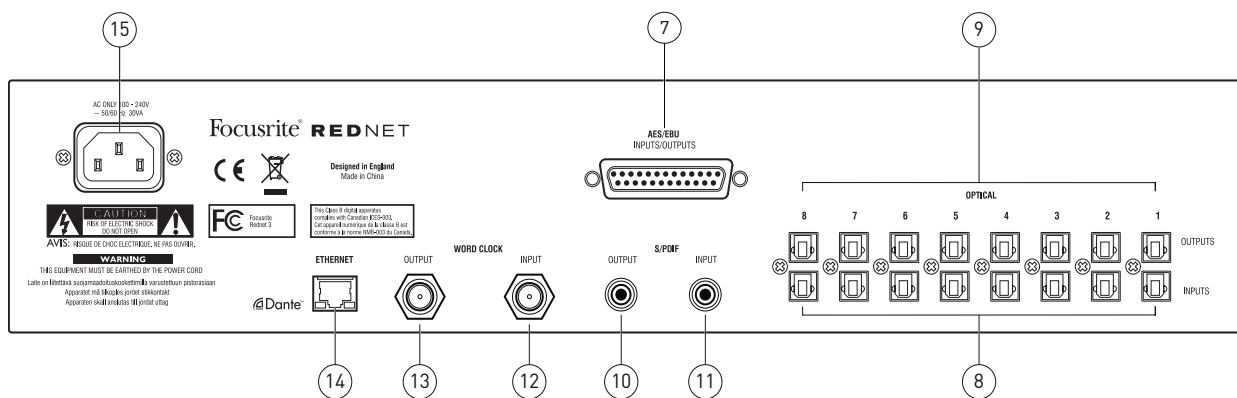

7. **AES/EBU INPUTS/OUTPUTS** – 25-pin female Dsub connector, conforming to AES 59, for connecting up to 8 digital audio sources (4 AES/EBU pairs) to the RedNet system, and also for outputting up to 8 digital audio channels (4 AES/EBU pairs). See page 12 for connector details.
8. **OPTICAL INPUTS 1-8** – these are for connection to a multichannel audio source with ADAT-format optical outputs. The connectors are TOSLINK type. Note that each connector carries eight separate audio channels at 44.1/48 kHz sample rate, four at 88.2/96 kHz, or two at 192 kHz.
9. **OPTICAL OUTPUTS 1-8** – optical TOSLINK type connectors each carrying ADAT-format digital audio bitstreams, with eight, four or two audio channels per connector depending on sample rate, as above.
10. **S/PDIF OUTPUT** – phono (RCA) socket carrying two channels of digital audio in S/PDIF (professional) format.

11. **S/PDIF INPUT** – phono socket allowing connection of the S/PDIF output of a digital audio device. The two channels connected here may be placed on the RedNet network, as selected in RedNet Control. The S/PDIF signal connected here may also be used as the unit's sync source.
12. **WORD CLOCK INPUT** – a BNC socket for the connection of a dedicated word clock sync signal, typically derived from a studio master clock source used to sync all the interconnected digital audio units in the system.
13. **WORD CLOCK OUTPUT** – a BNC socket from which a word clock signal may be obtained for connection to other digital audio devices outside the RedNet network. The clock signal available here will be derived from the source selected in software, and confirmed on the RedNet 3's front panel by LED.
14. **ETHERNET** – RJ45 network socket. Use a standard computer network cable to connect this socket to a local Ethernet switch to connect the RedNet 3 to the RedNet network. The socket has integral LEDs which illuminate to indicate connection to an active network port, and network activity. See page 13 for connector details.
15. AC mains inlet – standard IEC receptacle for connection of AC mains. RedNet 3 has a 'Universal' PSU, enabling it to operate from any supply voltages between 100 V and 240 V.

Physical Characteristics

RedNet 3's dimensions are shown in the diagram below:

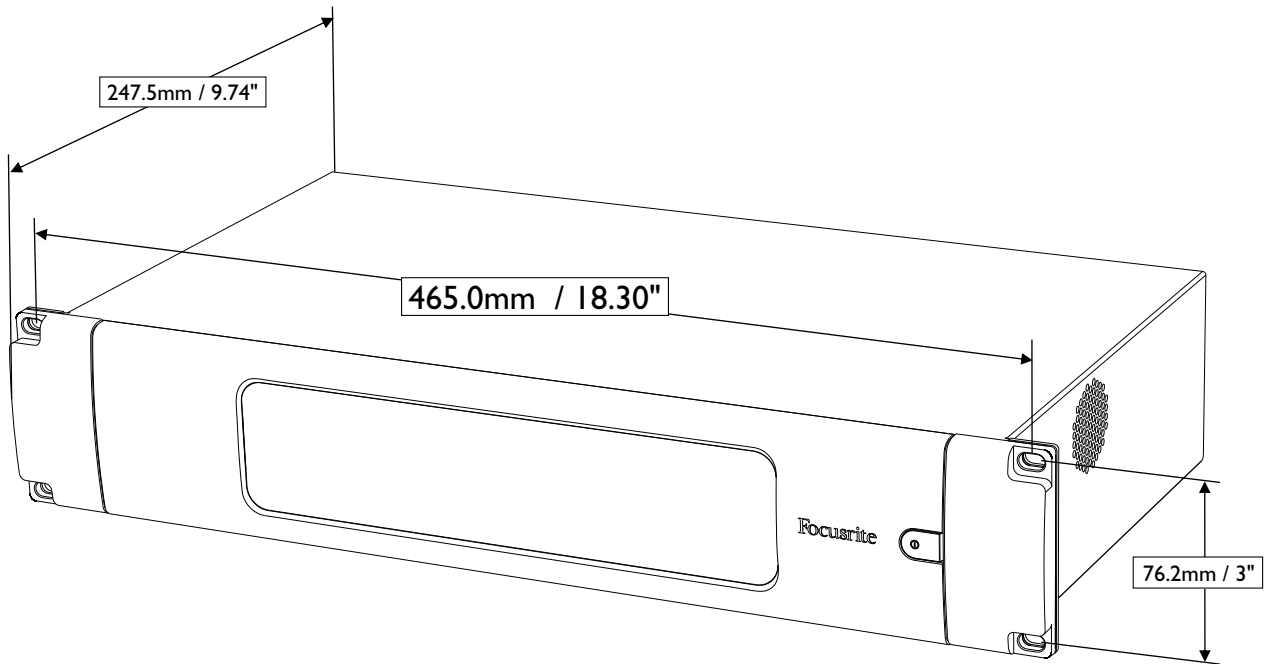

RedNet 3 requires 2U of vertical rackspace and at least 350 mm of rack depth, to allow for cables. RedNet 3 weighs 4.34 kg, and for installations in a fixed environment (e.g., a studio), the front panel mounting screws will provide adequate support. If the units are to be used in a mobile situation (e.g., flight-cased for touring, etc.), consideration should be given to using side support rails within the rack.

RedNet 3 generates no significant heat, and is cooled by natural convection. We recommend that the unit should not be used in locations where the ambient temperature is greater than 30°C.

Ventilation is via slots in the enclosure at both sides. Do not mount RedNet 3 immediately above any other equipment which generates significant heat, for example, a power amplifier. Also, ensure that when mounted in a rack, the side vents are not obstructed.

Power requirements

RedNet 3 is mains-powered. It incorporates a 'Universal' power supply, which can operate on any AC mains voltage from 100 V to 240 V. The AC connection is made via a standard 3-pin IEC connector on the rear panel. A mating IEC cable is supplied with the unit, which should be terminated with a mains plug of the correct type for your country.

The maximum rated AC power consumption of RedNet 3 is 30 VA.



Please note that there are no user-replaceable fuses in RedNet 3, or other user-replaceable components of any type. Please refer all servicing issues to the Customer Support Team (see "Customer Support and Unit Servicing" on page 16).

OTHER REDNET SYSTEM COMPONENTS

The RedNet hardware range includes various types of I/O interface and a PCIe digital audio interface card which is installed in the system's host computer. All the I/O units can be considered as "Break-Out" (and/or "Break-In") boxes to/from the network, and all are built in mains-powered, 2U 19" rackmounting housings. There are also three software items, RedNet Control (see below), Dante Controller and Dante Virtual Soundcard.

USING REDNET CONTROL

A virtual depiction of RedNet 3 will appear on-screen in RedNet Control when a unit is included in the active system.

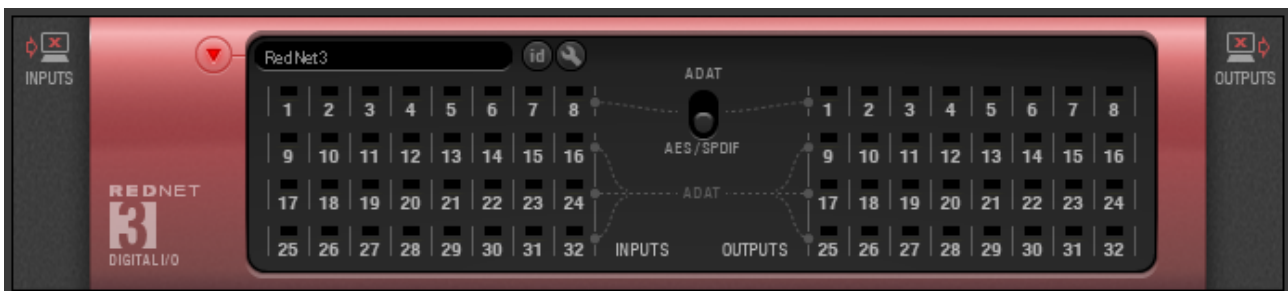

Port activity: Each of the RedNet 3's 32 inputs and 32 outputs has a virtual LED which illuminates to confirm the presence of an audio signal on that channel. Note that as the maximum number of channels is reduced at higher sample rates, the number of LEDs which may appear active is dependent on the sample rate.

ADAT/AES/SPDIF switch: Setting this switch to **AES/SPDIF** selects the source for Channels 1 to 8 to be the AES/EBU input connector instead of the first ADAT TOSLINK port. (Channels 1 and 2 may be alternatively sourced from the S/PDIF input - see Tools menu below). Note that Outputs 1 to 8 are always available at the AES/EBU connector as well as the ADAT port.

Tools menu : six options are offered:

- **Clock Source** – lets the user select the source of clock sync. The options available are:
 - **Internal** – sync is derived from RedNet 3's own internal clock
 - **ADAT** – sync is derived from ADAT input 1
 - **Word Clock** – select this when using an external master clock or when RedNet 3 is to be locked to some other piece of digital audio equipment outside the RedNet network.
 - **AES** – sync is derived from AES/EBU input signal, Channel 1
 - **S/PDIF** – sync is derived from the S/PDIF input signal
- **AES SRC** – Sample Rate Conversion is available on each of the four AES/EBU inputs and the S/PDIF input. Users may select which input(s) have SRC enabled; the source set in the Clock Source menu (above) will be the target clock for the SRC.
- **Word Clock Termination** – when set, applies a 75 ohm termination to the Word Clock In connector. This termination should be enabled unless units are connected using "T-Piece" connectors.
- **S/PDIF On** – enabling this option sets Input Channels 1 and 2 to be sourced from the S/PDIF input instead of the AES/EBU input. Note that the on-screen ADAT/AES/SPDIF switch must be set to AES/SPDIF for this option to function.
- **Preferred Master** - allows the user to set the unit to be the system master clock source. RedNet 3 must be set as preferred master when using an external clock source.

APPENDIX

Connector pinouts

AES/EBU digital audio input/output connector

Connector type: 25-pin female Dsub
 Applies to: AES/EBU INPUTS/OUTPUTS

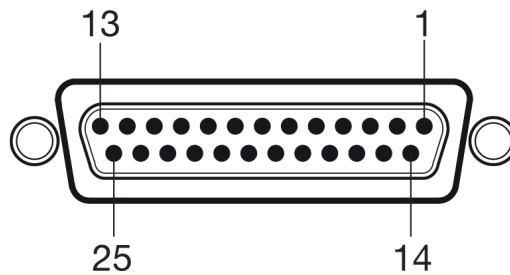

Pin	Signal	Pin	Signal
1	AES/EBU Ch D output 'hot' (+)	14	AES/EBU Ch D output 'cold' (-)
2	AES/EBU Ch D output screen	15	AES/EBU Ch C output 'hot' (+)
3	AES/EBU Ch C output 'cold' (-)	16	AES/EBU Ch C output screen
4	AES/EBU Ch B output 'hot' (+)	17	AES/EBU Ch B output 'cold' (-)
5	AES/EBU Ch B output screen	18	AES/EBU Ch A output 'hot' (+)
6	AES/EBU Ch A output 'cold' (-)	19	AES/EBU Ch A output screen
7	AES/EBU Ch D input 'hot' (+)	20	AES/EBU Ch D input 'cold' (-)
8	AES/EBU Ch D input screen	21	AES/EBU Ch C input 'hot' (+)
9	AES/EBU Ch C input 'cold' (-)	22	AES/EBU Ch C input screen
10	AES/EBU Ch B input 'hot' (+)	23	AES/EBU Ch B input 'cold' (-)
11	AES/EBU Ch B input screen	24	AES/EBU Ch A input 'hot' (+)
12	AES/EBU Ch A input 'cold' (-)	25	AES/EBU Ch A input screen
13	n/c		

AES/EBU Ch	Audio channels
A	1 & 2
B	3 & 4
C	5 & 6
D	7 & 8

Ethernet connector

Connector type: RJ-45 receptacle
Applies to: ETHERNET

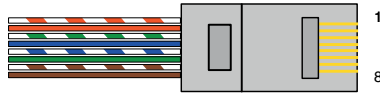

Pin	Cat6 Core
1	White + Orange
2	Orange
3	White + Green
4	Blue
5	White + Blue
6	Green
7	White + Brown
8	Brown

Word Clock I/O (Ext sync)

Connector type: 2 x 75 ohm BNC sockets
Applies to: WORD CLOCK INPUT and OUTPUT

S/PDIF I/O (Digital audio Chs 1 and 2)

Connector type: 2 x phono (RCA) sockets
Applies to: S/PDIF INPUT and OUTPUT

ADAT I/O (Digital audio Channels 1 – 64)

Connector type: TOSLINK
Applies to: OPTICAL INPUTS 1-8 and OUTPUTS 1-8

Performance Specifications

Inputs	
AES/EBU inputs	8 channels, with switchable SRC
AES/EBU connector	25-way female Dsub, wired to AES 59 (combined I/O)
ADAT inputs	32 channels @ 44.1 / 48 / 88.2 / 96 kHz sample rate; 16 channels @ 192 kHz
ADAT connectors	TOSLINK lightguides x 8
S/PDIF input	2 channels, with switchable SRC 44.1 to 192 kHz
S/PDIF connector	Phono (RCA) socket
AES/EBU Input Sample Rate Converters	
Input sample rate range	32 to 216 kHz
Gain error	-0.3 dB
Dynamic Range	> 138 dB (-60 dBFS method)
THD+N	< -130 dB (0.00003%); 0 dBFS input
Outputs	
AES/EBU outputs	8 channels, sync-locked to RedNet system sample rate
AES/EBU connector	See "Inputs"
ADAT outputs	32 channels @ 44.1 / 48 / 88.2 / 96 kHz sample rate; 16 channels @ 192 kHz
ADAT connectors	TOSLINK lightguides x 8
S/PDIF output	2 channels, sync-locked to RedNet system sample rate
S/PDIF connector	Phono (RCA) socket
Operating Modes	
AES/EBU mode	AES/EBU inputs – Chs. 1 to 8; ADAT inputs – Chs. 9 to 32*; AES/EBU outputs – Chs. 1 to 8; ADAT outputs – Chs. 1 to 32*
ADAT mode	ADAT inputs – Chs. 1 to 32*; AES/EBU outputs – Chs. 1 to 8; ADAT outputs – Chs. 1 to 32*
Digital Performance	
Supported sample rates	44.1 / 48 / 88.2 / 96 / 192 kHz
Clock sources	Local or from network master device
Local clock sources	Internal, Word Clock input, AES input 1, ADAT input 1, S/PDIF input
External word clock range	Sample rate \pm 7.5%
Power	
PSU	Internal, 100 - 240 V, consumption 30 VA

* Sample rate dependent – max. 16 channels at 192 kHz

Front Panel Indicators	
Power	Green
Network connected	Green
Sync lock	Green
Sample rate	Yellow x 5
Clock source	Yellow x 5
Signal present	Green x 16; illuminate at -128 dBFS

Focusrite RedNet Warranty and Service

All Focusrite products are built to the highest standards and should provide reliable performance for many years, subject to reasonable care, use, transportation and storage.

Very many of the products returned under warranty are found not to exhibit any fault at all. To avoid unnecessary inconvenience to you in terms of returning the product please contact Focusrite support.

In the event of a Manufacturing Defect becoming evident in a product within 12 months from the date of the original purchase Focusrite will ensure that the product is repaired or replaced free of charge.

A Manufacturing Defect is defined as a defect in the performance of the product as described and published by Focusrite. A Manufacturing Defect does not include damage caused by post-purchase transportation, storage or careless handling, nor damage caused by misuse.

Whilst this warranty is provided by Focusrite the warranty obligations are fulfilled by the distributor responsible for the country in which you purchased the product.

In the event that you need to contact the distributor regarding a warranty issue, or an out-of-warranty chargeable repair, please visit: www.focusrite.com/distributors

The distributor will then advise you of the appropriate procedure for resolving the warranty issue. In every case it will be necessary to provide a copy of the original invoice or store receipt to the distributor. In the event that you are unable to provide proof of purchase directly then you should contact the reseller from whom you purchased the product and attempt to obtain proof of purchase from them.

Please do note that if you purchase a Focusrite product outside your country of residence or business you will not be entitled to ask your local Focusrite distributor to honour this limited warranty, although you may request an out-of-warranty chargeable repair.

This limited warranty is offered solely to products purchased from an Authorised Focusrite Reseller (defined as a reseller which has purchased the product directly from Focusrite Audio Engineering Limited in the UK, or one of its Authorised Distributors outside the UK). This Warranty is in addition to your statutory rights in the country of purchase.

Registering your product

For technical support, please register your product at: www.focusrite.com/register

Customer Support and Unit Servicing

You can contact Focusrite Customer Support at:

Email: supportteam@focusrite.com

Phone (UK): +44 (0)1494 462246

Phone (USA): +1 (310) 322-5500

Troubleshooting

If you are experiencing problems with your RedNet 3, we recommend that in the first instance, you visit our Support Answerbase at: www.focusrite.com/answerbase